

Tools for Fiber Test & Monitoring



The challenge

of providing the increased bandwidth needed to support the development of services such as triple play is ongoing and can be daunting. Running optical fiber much deeper into the access network, in some cases all the way to the customer premises, is an important part of the strategy of every service provider. The appeal is that a fiber optic infrastructure offers the potential for practically unlimited bandwidth and also facilitates greater control over operating, administering, and provisioning the system.

Deployment, turn-up, and maintenance of fiber optic networks are in the core of the service provider's mission to ensure optimum quality of experience. Every stage of the network life cycle demands quality controls and proactive measurements to ensure integrity and efficiency of the optical transmission.

VIAVI offers a comprehensive portfolio of portable fiber optic test instruments and monitoring system solutions to cover all your network lifecycle needs for field testing, from installation and provisioning to maintenance and service assurance. From point solutions to highly scalable test platforms, technicians will always be equipped with the right tool to do the job right—the first time.



Table of Contents

Fiber Inspection & Cleaning 4

FiberChek™ Probe Microscope.....	5
FiberChek Sidewinder™.....	6
P5000i Fiber Microscope.....	7

Visual Fault Locators (VFL) and Fiber Identifiers 8

FFL-050/-100 Visual Fault Locators.....	8
FI-60 Live Fiber Identifier.....	9

Optical Handhelds..... 10

MP-60/-80 Miniature USB 2.0 Power Meters.....	10
SmartPocket™ OLP-34/-35/-38 Optical Power Meters.....	11
SmartPocket™ OLP-37 RfOG & PON and OLP-37X G-PON & XGS-PON Power Meters.....	12
SmartPocket™ OLS-34/-35/-36/-37/-38 Optical Light Sources.....	13
SmartClass OLA-55 Optical Level Attenuator.....	14
SmartClass Fiber OLP-82,-82P.....	14
SmartClass Fiber OLP-85 Optical Power Meter.....	15
SmartClass Fiber OLS-85 Handheld Light Source.....	15

Handheld Optical Test Kits..... 16

SmartPocket™ OMK-34/-35/-36/-38 Optical Test Kits.....	16
SmartClass Fiber OLTS-85/85P Optical Loss Test Sets.....	17
SmartClass Fiber MPOLx - MPO Optical Loss Test Sets.....	18

FTTx/PON Optical Power Meters 19

SmartClass Fiber OLP-87 PON Power Meters.....	20
SmartClass Fiber OLP-88 TruePON Tester.....	21
Network and Service Companion (NSC-100).....	22

OTDRs 23

Smart Link Mapper (SLM).....	23
SmartOTDR™ Handheld Fiber Tester.....	24
T-BERD/MTS-2000 Handheld Modular Test Set.....	25
T-BERD/MTS-4000 V2 Optical Test Platform.....	26-27
4100-Series OTDR Modules for T-BERD/MTS-2000, -4000, -5800 Platforms.....	28
FiberComplete Integrated Loss, ORL and OTDR Modules – 4100-Series for T-BERD/MTS-2000, -4000 V2 and -5800 Platforms.....	29
CWDM OTDR Modules – 4100-Series for T-BERD/MTS-2000, -4000 V2 and -5800 V2 Platforms.....	29
DWDM OTDR Module – 4100-Series for T-BERD/MTS-2000, -4000 V2, -5800 V2 Platforms.....	30
Multi-Fiber MPO Switch Module for T-BERD/MTS-4000 V2 Platform.....	31
T-BERD/MTS-6000A V2 Compact Network Test Platform.....	32
T-BERD/MTS-8000 Scalable Multitest Platform.....	33
8100-Series OTDR Modules for T-BERD/MTS-6000A V2, -8000 Platforms.....	34
FiberComplete Integrated Loss, ORL and OTDR Modules – 8100-Series for T-BERD/6000A V2, -8000 Platforms.....	35
Hi-Res Multimode OTDR Solution.....	36

Distributed Fiber Optic Sensing OTDRs 38

Distributed Temperature and Strain Sensor (DTSS) and Distributed Temperature Sensor (DTS).....	38-39
--	-------

Optical Dispersion Analysis..... 40

Optical Dispersion Measurement Module.....	40
Optical Broadband Sources for Dispersion Testing.....	41
Test results provided at the touch of a button.....	41

Optical Spectrum Analysis 42

COSA-4055 CWDM Optical Spectrum Analyzer Module for T-BERD/MTS-2000, -4000 V2, -5800 V2 Platforms.....	42
DWDM Optical Channel Checker Module (OCC-4056C) for T-BERD/MTS-2000, -4000 V2, -5800 V2 Platforms.....	43
OSA-110M/110H/110R Compact Full-Band OSAs.....	44
OSA-500M /500R/500RS High Performance Full-Band OSAs.....	45
OSA Modules: High resolution OSA-610 for T-BERD/MTS-6000A V2, -8000 Platforms.....	46
OSA Modules: In-service Pol-Mux OSA-710 for T-BERD/MTS-8000 Platforms.....	47
SmartClass OCC-55/-56 Optical Channel Checkers.....	48

Post-Analysis PC Software 49

Asset, Data, and Workflow Management 50

StrataSync™.....	50-51
CERTiFi.....	51

Optical Network Management..... 52

SmartOTU™.....	52
ONMSi: Optical Network Monitoring System.....	53

Improving Data Center Interconnect Uptime 54

Fiber Inspection and Cleaning

Contamination is one of the main causes of optical network failure. Just one particle of dust can cause permanent damage and interrupt traffic. Visual inspection is the only way to determine if fiber optic connectors need to be cleaned before coupling.

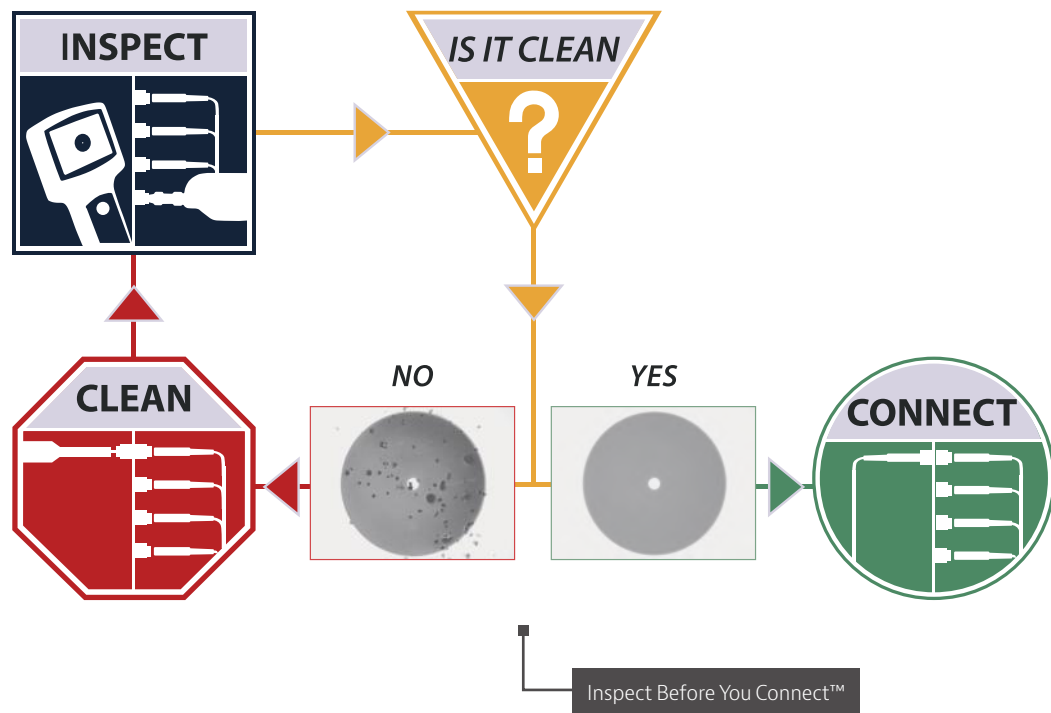

VIAMI offers a comprehensive product portfolio for inspecting every fiber connector and application in your network. Consistent use of the “Inspect Before You Connect” (IBYC) model ensures that proactive inspection is performed correctly every time prior to mating. This eliminates the installation of dirty or damaged fibers into the network and optimizes network performance.

For more information, visit www.viavisolutions.com/inspect



FiberChek™ Probe Microscope

The essential fiber tool for every technician!

The FiberChek probe builds on industry-leading expertise in fiber inspection to deliver an all-in-one handheld microscope for technicians at every skill level. Meeting all fiber inspection needs with built-in image viewing, auto-focus, pass/fail analysis, and result storage and recall, the FiberChek probe completely automates inspection workflows to ensure fast and accurate performance. Used alone or connected to other devices (via WiFi or USB), the FiberChek probe is the essential fiber tool for every technician.



Key Features

- Integrated touch screen to view fiber end faces
- Auto-center
- Auto-focus
- Built-in fiber end-face analysis
- User-selectable acceptance profiles
- Store results on device or export
- Connects via WiFi and USB

Key Benefits

- Achieve fully autonomous inspection with an all-in-one solution
- Automate inspection workflows
- Ensure accurate and fast test performance
- Easily access connections anywhere
- Connect with other VIAVI instruments and mobile devices

FiberChekMOBILE™

Available for both iOS and Android devices as a free download, FiberChekMOBILE integrates with VIAVI inspection solutions, giving users several additional capabilities.

- Manage and recall stored results
- View live images and operate controls from the mobile device
- Export results from probe microscopes to FiberChekMOBILE
- Generate certification reports
- Share results and reports via e-mail or cloud storage
- GPS tag the location of each test
- Input test information via full keyboard or voice-to-text dictation



FiberChek Sidewinder™

The latest addition to the award-winning FiberChek family, Sidewinder is the industry's first "all-in-one" handheld inspection and analysis microscope designed specifically for inspecting multifiber connectors such as MPO. This fully-automated and autonomous microscope improves inspection efficiency by up to 90%, greatly improving throughput and allowing technicians to finish work in a fraction of the time previously required.



Key Features

- Integrated touchscreen
- Live fiber viewing
- Auto-center
- Auto-focus
- Auto-pan/scroll
- Built-in fiber end-face analysis
- Audible sounds for Pass/Fail results
- User-selectable acceptance profiles
- Store results on device or export
- WiFi and USB connection to a PC or mobile devices
- All-day battery life
- Built in acceptance criteria to industry standards (IEC-61300-3-35)

Key Benefits

- Fully autonomous multifiber inspection
- Automate the inspection workflow
- Certify end face quality to customer requirements
- Ensure accurate and fast test performance with automatic test results at the press of a button
- Easily access connections in any location
- Connect with anything and test anywhere!

P5000i Fiber Microscope

The P5000i makes it fast and easy to certify that every connection in your network is clear and optimized. This intelligent fiber microscope removes the guesswork from fiber inspection and provides a reliable and objective pass/fail analysis of the fibers that connect customers to your network, ensuring the best user experience possible. The P5000i fiber microscope also works with the many VIAVI test solutions users already rely on for essential network testing.

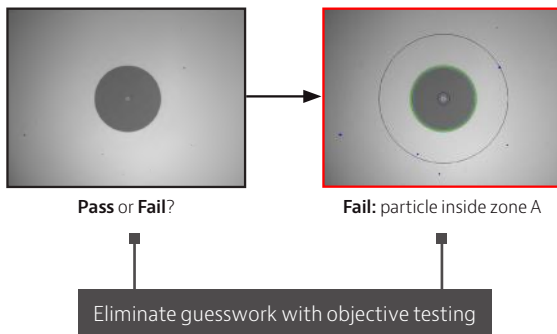

Applications

- Ensuring physical layer performance and conformance to industry standards
- Capturing, analyzing, and grading fiber end-face images
- Standardizing fiber inspection, analysis, and grading processes

Key Features

- Repeatable pass/fail analyses
- User-selectable acceptance criteria
- FiberChekPRO software for analysis and reporting with a PC/laptop
- Automatic image centering and dual-magnification switching
- Connect with other VIAVI instruments and mobile devices
- Connection to mobile Android™ or iOS devices/tablets using FiberChekMOBILE or WiFi adapter module

Features and Capabilities	FiberChek Probe	FiberChek Sidewinder	P5000i Probe	SmartClass Fiber Solutions
Dual (200/400x) magnification inspection of fiber end faces	■	■	■	■
Automatic pass/fail analysis to industry standards or custom requirements	■	■	■	■
Auto-center	■	■	■	■
Auto-focus	■	■		
Automatic report generation	■	■	■	■
Compatible with mobile devices	■	■	■	■
On-board storage	■	■		■
Fully autonomous operation	■	■		
Integrated display	■	■		■
Wireless operation	■	■		
MPO pass/fail analysis	1 Test = 1 fiber	1 Test = ALL fibers	Test = 1 fiber	Test = 1 fiber
Dedicated patch cord inspection microscope				Optional

Visual Fault Locators (VFL) and Fiber Identifiers

FFL-050/-100 Visual Fault Locators

A visual fault locator (VFL) is an essential tool that quickly and easily locates problem areas in fiber cables. By pinpointing the exact location of fiber damage, technicians can diagnose, troubleshoot, and fix the problem efficiently.

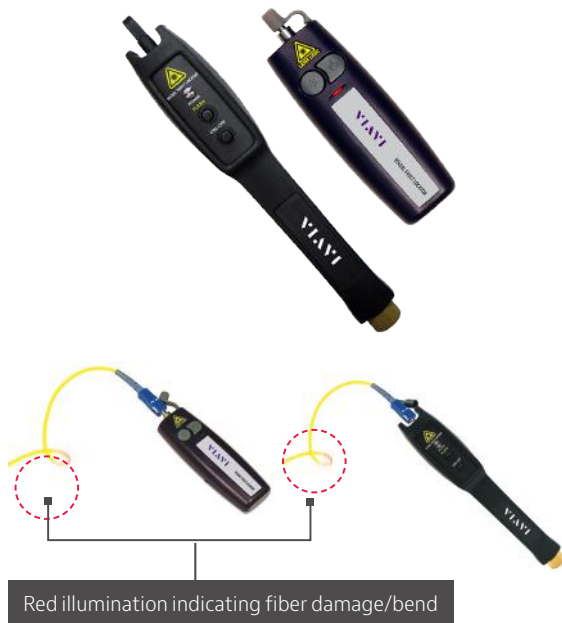

Applications

- Locating sharp bends, breaks, and damage to the fiber
- Conducting end-to-end continuity tests
- Performing fiber tracing and identification

Key Features

- Compact, ergonomic design for ultimate portability
- Visible wavelength at 650 nm
- High powered laser (1 mW) for singlemode (>7 km) and multimode (>5 km) connectors
- Continuous or flash illumination
- Universal connector interface for quick and easy connection
- 2.5 mm connector input (1.25 mm adapter available)
- Includes soft-sided carrying case with belt loop

FI-60 Live Fiber Identifier

The VIAVI FI-60 LFI enables users to easily detect the presence of an optical signal without disconnecting fiber or disrupting network traffic. FI-60 LFI also includes the unique SafeChek™ system, which ensures safe and repeatable engagement with most fiber types without the hassle of changing out costly dies. The FI-60 also converts to an Optical Power Meter (OPM), providing twice the value for your investment and reducing the number of tools carried on the job.



Applications

- Detecting an optical signal without having to disconnect the fiber
- Installation, service, maintenance, or troubleshooting

Key Features

- LFI head accepts multiple cable diameters (250 μ m to 3 mm jacketed fibers)
- Durable metal input adapters (2.5 and 1.25 mm) for OPM
- Measures both absolute (dBm) and relative (dB) power
- Stores and recalls up to 100 OPM readings

VIAVI also provides F1-10/-11 Optical Fiber Identifiers that identify optical fibers by detecting the optical signal being transmitted through a single-mode fiber.



Optical Handhelds

VIAVI offers the largest portfolio worldwide of power meters, PON power meters, return loss meters, light sources, loss test sets, variable attenuators, talk sets, and optical channel checkers. A pioneer in optical handheld instrumentation for more than 30 years, VIAVI has more than 150,000 optical handhelds already in use and has developed products that are recognized worldwide for their quality, reliability, ease of use, and low cost of ownership.

MP-60/-80 Miniature USB 2.0 Power Meters

Quickly connecting to a PC/laptop, smartphone, or tablet, these power meters have size, functionality, and ease-of-use characteristics that make them extremely useful and practical tools for testing optical power levels. The simple, straightforward, and intuitive software interface offers a well-organized digital solution to both fiber inspection and test procedures.



Applications

- Measuring general power and loss as well as high power applications in long-haul, metro, access, and local area networks with wavelengths ranging from 780 to 1625 nm
- Use with a VIAVI light source to detect modulation frequency and identify individual fibers

Key Features

- Lightweight, small form-factor design for ultimate portability
- Generates measurements in dB, mW, and dBm
- Automated data logging capabilities
- Automatic wavelength detection
- Easily connect to VIAVI test devices (ONX-580, ONX-620 & 630, T-BERD/MTS-2000/4000V2, CellAdvisor, DSAM, SmartOTDR), PCs, and mobile devices

SmartPocket™ OLP-34/-35/-38 Optical Power Meters

These pocket-sized, cost-effective optical power meters and light sources are ideal for the installation and maintenance of singlemode and multimode fiber optic networks because they offer ergonomic design with large displays and straightforward user interfaces.

SmartPocket optical power meters (OLP-34, OLP-35, and OLP-38) offer an excellent price/performance ratio in a rugged and pocket-sized housing for straightforward use in the field. Used primarily to measure optical power level (dBm) in premises, telco, or CATV fiber optic networks, they also can be combined with LED (OLS-34/OLS-36) or laser light sources (OLS-35/OLS-36) for insertion loss measurement.

Applications

- The OLP-34 is dedicated to LAN/WAN access and enterprise multimode or single mode applications
- The OLP-35 covers all standard singlemode telecommunication networks
- The OLP-38 is the higher power (+26 dBm) version for any CATV (with analog RF transmission) or amplified DWDM system applications

Key Features

- Extra long battery lifetime (>200 hr)
- Universal optical interface for all 2.5 mm/1.25 mm connector
- Individually-setable wavelengths per 1 nm step
- Micro USB interface for power supply or data transfer



SmartPocket™ OLP-37 RFoG & PON and OLP-37X G-PON & XGS-PON Power Meters

The specialized VIAVI SmartPocket OLP-37 optical power meter can be used to conduct measurements during passive optical network (PON) and Radio Frequency over Glass network (RFoG) activation, maintenance, and troubleshooting. It can measure wavelength-selective optical power when testing B-PON, E-PON, or G-PON networks, as defined in ITU-T G.983/4, or IEEE 802.3ah, and RFoG systems, as defined in SCTE 174 2010.

The SmartPocket OLP-37X optical power meter can be used to conduct measurements during passive optical network (PON) activation, maintenance, and troubleshooting. It can measure wavelength-selective optical power when testing B-PON, E-PON, or G-PON networks, as defined in ITU-T G.983/4, or IEEE 802.3ah and XGS-PON networks, as defined in ITU-T G.9807.1.

Applications

- All-in-one universal RFoG and PON power meter (OLP-37 RFoG & PON)
- Testing B-PON, E-PON, G-PON downstream at 1490 nm
- Testing RFoG/video at 1550 nm downstream and at 1610 nm return path

Key Features

- Wavelength-selective PON and RFoG power meter
- Wavelength-selective G-PON and XGS-PON power meter (OLP-37X)
- Tests B-PON, E-PON, G-PON downstream at 1490 nm (OLP-37X)
- Tests XGS-PON at 1550 nm downstream and at 1577 nm (OLP-37X)
- Indication of simultaneous presence of G-PON and XGS-PON signals (OLP-37X)
- Internal memory can hold 100 test results
- Interchangeable FC/APC and SC/APC optical adapters
- Transfer data via micro USB interface
- Smart Reporter PC software for data management and report generation
- Uses dry or rechargeable batteries



SmartPocket™ OLS-34/-35/-36/-37/-38 Optical Light Sources

SmartPocket optical light sources (OLS-35 and OLS-36) are the ideal complementary tools to the OLP-3x to measure the insertion loss and test the continuity in multimode datacom and local area networks as well as in singlemode telecommunication and CATV-multimedia networks.



Applications

- The OLS-34 is dedicated to LAN/WAN access and enterprise multimode networks with 850/1300 nm
- The OLS-35 covers all standard singlemode telecommunication networks applications with 1310/1550 nm
- The OLS-36 is a quad-wavelength solution covering both multimode and singlemode wavelengths in one product (850/1300/1310/1550 nm)
- The OLS-37 is a singlemode source with 3 wavelengths on one port for testing FTTH/PON networks at 1310/1550 nm and 1490 nm
- The OLS-38 is a singlemode source with 3 wavelengths on one port for testing networks at 1310/1550 nm and 1625 nm

Key Features

- Cost-effective, rugged, and compact optical light sources
- Switchable optical adapter versions available for maximum flexibility
- Auto λ and TwinTest transmission modes
- 3-year calibration
- Combines up to 4 wavelengths in one instrument (SM+MM)
- Micro USB interface for power supply
- One output port for 2 or 3 wavelengths (depending on model)

SmartClass OLA-55 Optical Level Attenuator

High-performance SmartClass optical handhelds combine high functionality with straightforward operation and compact design to provide a complete line of optical power meters, light sources, optical attenuators, test kits, loss test sets, return loss meters, channel checkers, tunable laser sources, and optical talk sets for every field application in fiber optic networks.

SmartClass OLA-55 optical level attenuator is a variable attenuator for singlemode fiber system testing.



Applications

- Emulating fiber loss for testing system dynamics
- Simulating line loss for BER testing and amplifier testing
- System installation and maintenance of multimode fiber (OLA-54) and singlemode fiber

Key Features

- Robust, shock-proof, and splash-proof design for field operation
- USB port for remote operation
- Absolute and relative attenuation setting
- Traceable measurements to NIST/PTB standards for confidence in accuracy
- 400 adjustable wavelengths
- Long battery operation time (>1000 hr)

SmartClass Fiber OLP-82,-82P

SmartClass™ Fiber is a product family of handheld test tools that integrate fiber inspection, optical testing and PASS/FAIL certification together in a single device. With SmartClass Fiber, technicians obtain ultimate flexibility and performance in a powerful, yet easy to use solution that can turn any technician into an instant fiber expert.



Applications

- Measurement of optical power (absolute and relative)
- Measurement of optical insertion loss
- Inspecting fiber end faces – both patch cord and bulkhead

Key Features

- Multiple calibrated wavelengths from 780 to 1625 nm
- 3.5 inch color touch screen.
- Automated pass/fail fiber inspection analysis with optional P5000i microscope
- Available with integrated patchcord microscope
- Supports both industry-standard and user definable acceptance criteria
- On board storage of fiber inspection and test results
- Integrated reporting capability and off-line certification software to create customized reports

SmartClass Fiber OLP-85 Optical Power Meter

The OLP-85 high performance optical power meter is a professional, versatile, and compact instrument perfect for any fiber-optic network power or loss test applications. The OLP-85 perfectly fits applications where low power or very high power needs to be measured thanks to its high accuracy over an ultra-wide 100 dB dynamic range. The OLP-85 combines an optical power meter with pass/fail fiber inspection analysis capability into one portable solution.



Applications

- Measurement of optical power (absolute and relative)
- Measurement of optical insertion loss together with a VIAVI optical light source OLS-3x or OLS-8x
- Inspection of optical connectors (requires a P5000i microscope)

Key Features

- Multiple calibrated wavelengths in the range of 800 to 1700 nm
- 3.5 inch color touch screen with integrated stylus
- Individual threshold settings for power and loss pass/fail analysis
- Data transfer and remote control via USB or Ethernet interface
- Auto-lambda and multi-lambda test functions in combination with VIAVI optical light sources
- Automated pass/fail fiber inspection analysis with optional P5000i microscope

SmartClass Fiber OLS-85 Handheld Light Source

The SmartClass Fiber OLS-85 handheld light source is a professional, versatile, and compact instrument used for fiber-optic network qualification and certification. Its specific wavelength combinations make it optimal for link loss testing and long-haul, metro, and access telecommunication network characterization, as well as data center and local area network testing.



Applications

- Measurement of fiber insertion loss together with a VIAVI optical power meter OLP-3x or OLP-8x
- Inspection of optical connectors (requires a P5000i microscope)

Key Features

- 3.5 inch color touch screen with integrated stylus
- Battery-operated field-portable optical light sources with 1310/1550 nm wavelengths
- Interchangeable SC and FC optical adapters
- Auto-lambda and multi-lambda test functions in combination with VIAVI optical power meters

Handheld Optical Test Kits

SmartPocket™ OMK-34/-35/-36/-38 Optical Test Kits

SmartPocket optical test kits include an optical light source (OLS-3x), a power meter (OLP-3x), and additional accessories.

Applications

- The OMK-34 is a dual-wavelength optical test kit with a single-port LED source (OLS-34) and a power meter with a universal push/pull adapter (UPP) interface (OLP-34) for power and loss measurement in singlemode and multimode LAN/WAN and enterprise networks
- The OMK-35 is a dual-wavelength optical test kit with a single-port laser source (OLS-35) and a power meter with a UPP interface (OLP-35) for singlemode power measurement and loss test in access and metro networks
- The OMK-36 is a quad-wavelength optical test kit with a dual-port light source (OLS-36) and a power meter with a UPP interface (OLP-35) for singlemode and multimode power and loss measurement
- The OMK-38 is a dual-wavelength optical test kit with a single-port laser source (OLS-35) and a power meter with a UPP interface (OLP-38) for singlemode power and loss measurement especially in high-power CATV networks

Key Features

- Power meter: extra long battery lifetime (>200 hr)
- Power meter: universal optical interface for all 2.5 mm/1.25 mm connector
- Power meter: individually settable wavelengths per 1 nm step
- Light source: one output port for 2 wavelengths
- Micro USB interface for power supply or data transfer



SmartClass Fiber OLTS-85/85P Optical Loss Test Sets

VIAVI SmartClass Fiber OLTS-85/85P lets installers and technicians work fiber smart by integrating industry-leading fiber inspection with Tier 1 testing. This efficient, easy-to-use solution promotes best practices while cutting testing and certification time in half. Have confidence in your network quality and optimize your workflow with a single solution

Applications

- Comprehensive tier 1 fiber testing to TIA/ISO/IEC standards
- Inspecting fiber end faces—both patch cord and bulkhead
- Generate certification reports

Key Features

- Dedicated multimode, singlemode, and quad versions
- 3.5 inch color touch screen
- Measures length & optical loss (two fibers, two wavelengths), with polarity check
- Encircled flux compliant
- Automated pass/fail fiber inspection analysis with optional P5000i microscope
- Available with integrated patchcord microscope
- Direct reports via FiberChekPRO™ reporting software



SmartClass Fiber MPOLx - MPO Optical Loss Test Sets

The VIAVI SmartClass Fiber MPOLx is the industry's first dedicated optical loss test set that can perform all the test requirements for Tier 1 (Basic) certification using MPO fiber connectivity.

The MPOLx gives technicians the ability to achieve a completely new level of productivity for MPO testing and certification. Like all our solutions for Tier 1 (Basic) fiber certification, identical local and remote units are provided to enable full visibility and control by performing tests from both the Light Source and Power Meter. All devices feature a 3.5 inch color touch screen and integrated inspection for both bulkhead and trunk connectors. The MPOLx allows a single technician to inspect MPO end faces and perform tests from either end of the connection, reducing walking back and forth between the two units. The MPOLx ensures fast workflows by delivering comprehensive test results in less than 6 seconds for all 12 fibers of the MPO connector providing color coded pass/fail test results, test limit, fiber length, test wavelengths, loss values, margins, and polarity results for each MPO fiber. The MPOLx provides a source and power meter that integrate essential MPO test capabilities together to ensure a fast and reliable workflow when testing and certifying network links with native MPO connectivity.

Applications

- Comprehensive Tier 1 (Basic) fiber certification for MPO fiber connectivity
- Inspect fiber end faces
- Generate certification reports

Key Features

- Measures length
- Measures optical loss at multiple wavelengths
- Checks polarity for all 12 MPO fibers
- Delivers test results for all 12 MPO fibers in <6 seconds
- Provides native MPO end-face inspection and automated analysis for both trunk cables and bulkheads
- Dual wavelength optical light sources
- Encircled flux compliant
- All-day battery life



FTTx/PON Optical Power Meters

A PON power meter is a test instrument for FTTx network service activation and troubleshooting. Through-mode capability allows the simultaneous measurement and display of both the continuous downstream wavelengths (for data and RF video) and the bursty upstream wavelengths. Preset industry standards or user definable criteria provide clear Pass/Fail indicators and ensure both the network and customer installs are meeting required specifications.

The new generation of PON tester performs downstream and upstream PON power level measurements like traditional PON power meters and identifies ONU/ONT by serial number with detection of rogue/alien ONUs/ONTs. For GPON systems carrying PON-ID, it also identifies OLT.

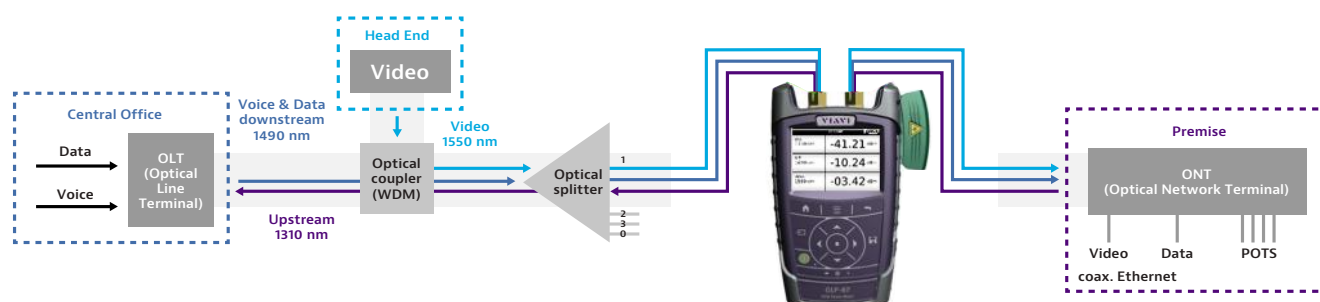

In addition the new generation of PON testers can use PON-ID information and G-PON data analysis to determine ONU/ONT service activation status, allowing techs to check if an ONU/ONT is provisioned correctly with the OLT and to verify an ONU/ONT is routed to or connected to the correct OLT port. Plus checking for any rogue or alien ONU/ONT devices potentially disrupting service to other customers.

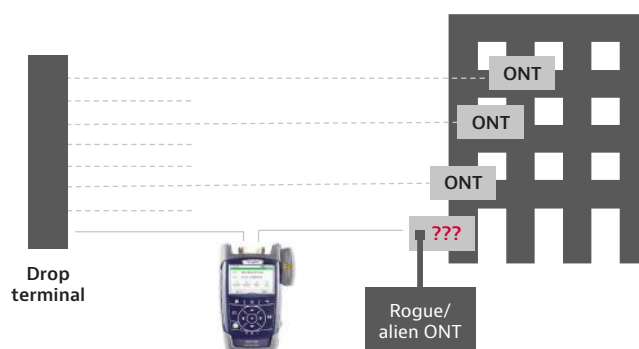

SmartClass Fiber OLP-87 PON Power Meters

The OLP-87 is an FTTx/PON power meter for use in activating and troubleshooting B-PON, E-PON, G-PON and high speed 10G PON such as XG-PON and 10G-EPON networks, plus the next generation of NG-PON2 networks. The OLP-87 combines a high-performance wavelength-selective power meter with pass/fail fiber inspection analysis capability in one portable solution.



Applications

- FTTx/PON network service activation and troubleshooting
- Simultaneous power measurement of upstream and downstream signals on live PON networks
- Automated pass/fail fiber inspection

Key Features

- Field-portable λ -selective PON power meter with through-mode capability
- Variations of 1490/1550/1578 nm downstream and 1270 nm/1310 upstream
- Individual NG-PON2 downstreams and upstream power levels
- Pre-defined threshold sets for auto Pass/Fail analysis of PON power measurements
- High performance broadband power-meter option
- Automated pass/fail fiber inspection analysis with optional P5000i microscope
- Integrated patchcord microscope version available

SmartClass Fiber OLP-88 TruePON Tester

The OLP-88 TruePON tester is the ideal tool for field technicians dealing with GPON network service activation and for support teams charged with resolving service complaints and identifying the sources of issues. TruePON uses GPON data analysis for real-time measurement of fiber optic cable insertion loss, downstream and upstream power levels, ODN class, and for instantaneous identification of OLT-ID ONU/ONT-ID as well as rogue ONUs causing service issues. The OLP-88 ensures more reliable PON tests and faster troubleshooting of network issues.



Applications

- GPON ONT activation process verification
- OLT and ONT identification (serial number extraction)
- PON signal automatic power level measurement and certification
- Rogue ONUs or alien device identification
- Automated pass/fail fiber inspection

Key Features

- GPON ONT activation process verification
- OLT and ONT identification (serial number extraction)
- GPON signals automatic power level measurement and certification
- Rogue ONUs or alien devices identification
- Automated pass/fail fiber inspection analysis with optional P5000i microscope
- Integrated patchcord microscope version available
- Up to 10,000 measurement results storage
- Data transfer via USB, Ethernet or optional WiFi connection

Network and Service Companion (NSC-100)

The Network & Service Companion is a new category of compact hand-held device combining multiple test interfaces (PON, Ethernet, WiFi) with the VIAVI 'OneCheck' application concept to make network validation and high speed (Gigabit) service testing a simple and speedy process for all frontline techs and installers, be they beginner or expert.

NSC-100 is a single high-performance tool that allows techs to operate in multiple network environments and applications allowing network delivery and service performance to be easily documented with clear and fast demarcation/segmentation of any issues in just a few minutes.

A compact, screenless instrument for techs and contractors handling installation, activation and troubleshooting of residential broadband, business services and Metro/Enterprise Ethernet services. Benchmarking network delivery, validating service performance and distribution while driving compliance to best practice to simply test everything anywhere.



VIAVI StrataSync enabled

Applications

- Verify true customer experience and physical network layer on all G-PON, Ethernet & WiFi test interfaces
- Benchmarking of service delivery to a premises and distribution within premises
- PON/FTTH test for both residential and business services
- Metro/Ethernet test for Enterprise/ DataCenter, business services and wireless fronthaul (4G & 5G)

Key Features

- Simply test everything anywhere – PON, Ethernet, WiFi
- PON test interface with ONT emulation & G-PON ID data analysis
- Ethernet test interfaces up to 10G, up to Layer 4 (TCP/UDP)
- Ethernet L2/L3 loop back support for Y.1564 & RFC-2544 tests
- High-end WiFi test interface – 3x3 WiFi antenna with 2.4 & 5GHz
- Multiple levels of gigabit throughput testing (Ookla Speedtest, TrueSpeed RFC-6349, FTP SpeedCheck) for service evaluation against whatever benchmark is needed
- Service speed tests available through all test interfaces
- Share reports directly via email
- Operated via Mobile Tech App (iOS & Android), OneExpert (ONX), T-BERD/MTS platforms
- StrataSync enabled

OTDRs

An OTDR is a fiber optic tester for the characterization of optical networks that support telecommunications. The purpose of an OTDR is to detect, locate, and measure elements at any location on a fiber optic link. An OTDR needs access to only one end of the link and acts like a one-dimensional radar system. By providing pictorial trace signatures of the fibers under test, it's possible to get a graphical representation of the entire fiber optic link.

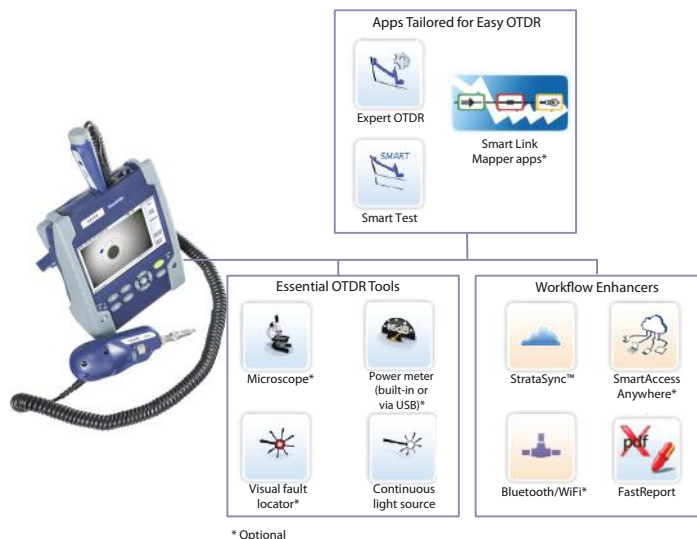

Smart Link Mapper (SLM)

An optical time domain reflectometer (OTDR) is an essential fiber test tool that helps service providers ensure that their fiber network infrastructure is optimized to deliver reliable and robust services. OTDR operation and usability has been simplified over the years; however, it is still considered an advanced instrument to operate and interpreting measurement results can be complex. The Smart Link Mapper (SLM) intelligent optical software application helps technicians use an OTDR more effectively, without the need to understand or interpret OTDR results. Each event is displayed as an icon giving users a schematic view of the entire link, known as SmartLink. SLM can completely correlate to the original OTDR trace as experts desire.

With this common approach to simplify OTDR testing and streamline the procedures, four tailored SLM OTDR applications are available for different network types Enterprise-SLM, FTTA-SLM, FTTH-SLM and Cable-SLM.

Applications

- Installation and commissioning of enterprise, access, and metro networks
- Installation and maintenance of wireless backhaul
- Link characterization of long/xWDM networks
- Troubleshooting of any fiber network
- Singlemode and multimode fiber links

Key Features

- Eliminates OTDR results interpretation complexity
- Directly correlates SmartLink view results and OTDR trace
- Immediately diagnoses problems
- Automatic pass/fail results
- Compatible with all multimode/singlemode and OTDR modules
- Enabled on SmartOTDR and all recent T-BERD/MTS-2000, -4000 V2, -6000A V2, and -8000 OTDR platforms
- Upgradable on site

SmartOTDR™ Handheld Fiber Tester

The SmartOTDR essential handheld fiber tester is an affordable, easy-to-use device for techs at any skill level, with robust wireless connectivity options that increase productivity anywhere. It integrates all essential fiber test requirements into a single device with OTDR measurement, fiber end-face analysis, optical loss testing, and a visual fault locator.

Applications

- Characterize point-to-point access and metro fiber networks
- Qualify and troubleshoot FTTH/PON networks
- Qualify and troubleshoot singlemode FTTA/DAS fronthaul

Key Features

- 5 inch touch-screen display
- Single-/dual-/tri-wavelength versions with 1310, 1550, and in-service 1625 or 1650 nm wavelengths
- PON optimized to test through a 1x128 splitter (B version)
- Integrated CW light source on OTDR port
- Built-in optical power meter and VFL options
- Automated pass/fail fiber inspection analysis with optional P5000i microscope
- Smart Link Mapper (SLM) eliminates OTDR interpretation errors without impacting test times



VIAMI StrataSync enabled

T-BERD/MTS-2000 Handheld Modular Test Set

The T-BERD/MTS-2000 is a handheld modular test set for the installation, turn-up, and maintenance of optical fibers across enterprise, metro, and FTTH/access point-to-point or point-to-multipoint networks (PONs).

The T-BERD/MTS-2000 provides the largest range of test capabilities offered in one handheld unit. The modular design gives service providers the maximum flexibility to scale their investment and evolve with the growth of their network. The instrument supports the whole range of essential fiber analysis tools including connection inspection, connection check, light source and power meter. As well as standard OTDR modules, PON optimized OTDR modules, CWDM and DWDM OTDR modules, and CWDM optical spectrum analyzer module.



VIAMI StrataSync enabled

Applications

- Characterize point-to-point access and metro fiber networks
- Qualify and troubleshoot FTTH/PON networks
- Qualify and troubleshoot singlemode or multimode FTTH/DAS/C-RAN fronthaul
- Qualify and troubleshoot multimode fiber links in LAN/WAN, enterprises, and data centers
- Characterize and troubleshoot fiber links with exact CWDM & DWDM wavelengths
- FiberComplete fully automated bi-directional IL/ORL & OTDR certification

Key Features

- 5 inch touch-screen display
- Single-/dual-/tri-wavelength versions with 1310, 1550, and in-service 1625 or 1650 nm wavelengths
- Dual multimode (850/1300 nm) or quad wavelengths multimode/singlemode (850/1300/1310/1550 nm) versions
- PON optimized to test through a 1x256 splitter
- Automated pass/fail fiber inspection analysis with optional P5000i microscope
- OTDR modules are compatible with T-BERD/MTS-4000 V2 multiple services test platforms
- Smart Link Mapper (SLM) eliminates OTDR interpretation errors without impacting test times
- Built-in optical power meter and VFL options

T-BERD/MTS-4000 V2 Optical Test Platform

The T-BERD/MTS-4000 V2 is a small, compact and handheld test platform designed for all phases of the network lifecycle, from the installation to the maintenance of Metro, Core, Access, FTTH, FTTx, HFC, Wireless, 5G, Enterprise and Data Center networks. Modular in design, the T-BERD/MTS-4000 V2 offers engineers, technicians, installers and contractors the highest performance and superior levels of scalability and upgradeability.



VIAMI StrataSync enabled

Applications

- Full network lifecycle: Construction, Activation, Maintenance & Troubleshooting
- Essential fiber test: OTDR, FiberComplete™ (automated bi-directional IL/ORL & OTDR), Connector inspection with IEC Pass/Fail Analysis
- FTTH: PON optimized OTDR & selective power meters for E-PON, G-PON, XGS-PON, NG-PON2 networks
- Hybrid CWDM/DWDM: combined CWDM or DWDM OTDR and C-OSA test platform
- Wireless: singlemode and multimode test for C-RAN, DAS and 5 G deployments
- Enterprise & Data Center: integrated solution for multi-fiber MPO cable tier-2 certification
- Metro Core: long haul OTDR for high speed 10 G/40 G/100 G fiber link qualification

Key Features

- Lightweight platform: only 1.4 kg / 3 lbs
- 9 inch high visibility multi-touch screen with permanent function keys
- Dual-modular platform with field-replaceable modules
- Essential tools integrated and supported in the platform (visual fault locator, optical power meter, optical microscope and talkset)
- Smart Access Anywhere (SAA) for remote control & field tech support
- StrataSync enabled – centralized cloud based asset, configuration, test data and workflow management
- Report Generation – on-board instrument, via PC/laptop (FiberCable SW suite) and StrataSync
- Cost-effective (3yr warranty), compact and handheld platform

The T-BERD/MTS-4000 V2 platform is a highly integrated optical test platform with two module bays, a large 9 inch color touchscreen with multi-touch capability, enabling the use of many optical test functions. It supports the range of VIAVI fiber analysis tools including OSA, OTDR, bidirectional insertion loss/ORL, light source, power meter, and connector inspection.

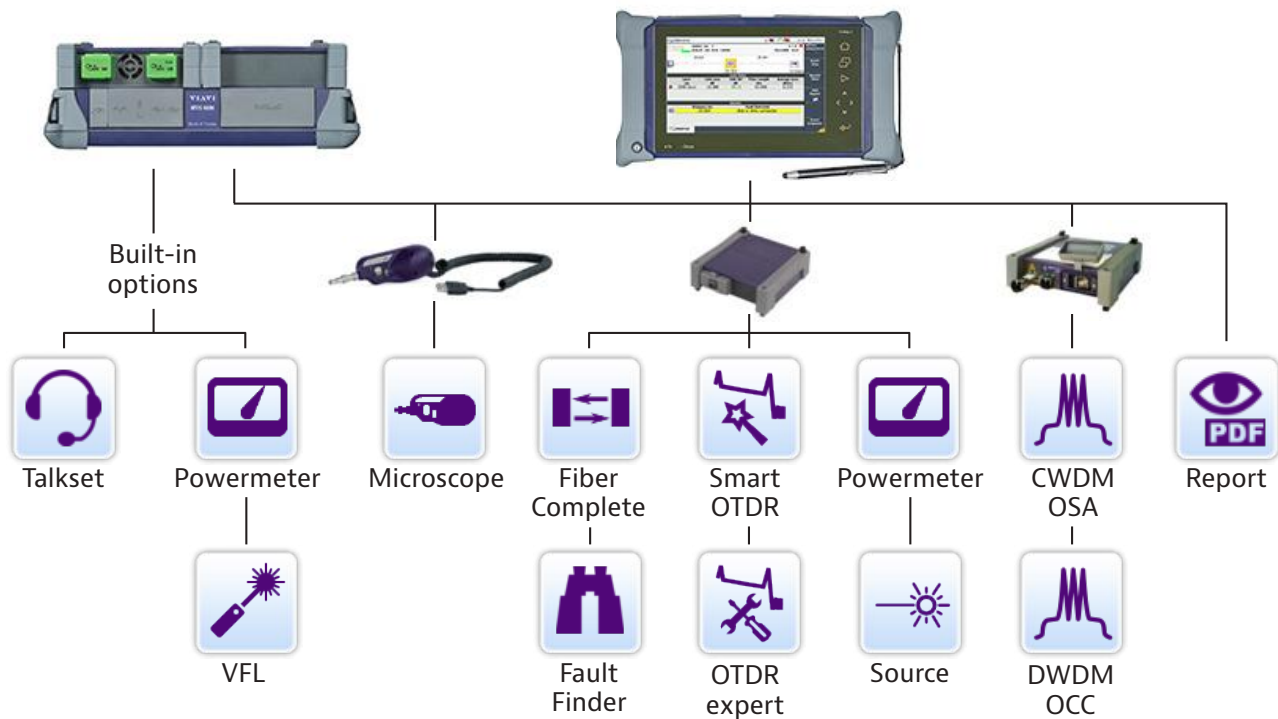

4100-Series OTDR Modules for T-BERD/ MTS-2000, -4000 V2, -5800 V2 Platforms

VIAVI 4100-Series OTDR modules let field technicians rapidly, reliably, and cost-effectively install, turn-up, and troubleshoot any optical network architecture—enterprise, metro, and FTTx/access point-to-point or point-to-multipoint passive (PONs). The OTDR modules' optical performance, combined with the complete suite of T-BERD/MTS platform testing features, ensures that testing is done right—the first time.

Standard testing features include:

- Automatic macrobend detection
- Summary results table with pass/fail analysis
- Bidirectional OTDR analysis
- Fast-Report — onboard report generation



FiberComplete Integrated Loss, ORL and OTDR Modules – 4100-Series for T-BERD/MTS-2000, -4000 V2 and -5800 V2 Platforms

You can now equip each technician with a single piece of equipment that fulfills all of the traditional fiber testing requirements. FiberComplete is the only solution to perform all the fundamental fiber-qualification tests, such as bidirectional insertion loss (IL), optical return loss (ORL), and optical time domain reflectometry (OTDR) in one module from one optical port, using one fiber connection with one button-push operation. FiberComplete cuts testing in half with fewer connection and disconnections, automatic continuity check and an intelligent fault finder, minimizes training and gets reliable measurements using a fully automated process with easy-to-read results, and optimizes workflow by compiling tests results into one complete cable view and automatically storing all measurements in one folder. Based on the 4100 series MA3 modules this unique automated solution saves 50% testing time on fiber optic network deployment and is the only bi-directional loss test set on the market that can characterize splices and connectors, and locate faults.

IL/ORL Results				
Wavelength	Pass/Fail	1310 nm	1490 nm	1550 nm
Loss B->A	✘	17.78	11.42	10.40
Loss A->B	✘	17.88	11.42	10.72
Avg Loss	✘	17.83	11.42	10.56
ORL A	✔	30.73	30.53	30.85
ORL B	✔	28.11		28.83

Applications

- Certification, maintenance and troubleshooting of any fiber optic links
- Installation and commissioning of Access, Middle Mile and Metro networks
- FTTH/PON network construction and acceptance testing
- Automatically measure bidirectional OTDR, IL, and ORL with one unit
- Troubleshoot in FaultFinder mode for immediate results

Key Features

- Single module, single port testing
- Make one connection, one-touch automated measurements
- Approx. 2 min 40 secs for full bidirectional certification (inc. report generation)
- Real-time continuity check and automatic product pairing
- Full setup exchange between instruments
- Manage fiber and cable results with on-board report generation
- Step by step wizard for initial IL/ORL test referencing
- Based on MA3 module, supported on T-BERD/MTS-2000, -4000 V2 and -5800

CWDM OTDR Modules – 4100-Series for T-BERD/MTS-2000, -4000 V2 and -5800 V2 Platforms

VIAVI CWDM OTDR solution enables cable operators, dark fiber providers and telecommunication service providers to test through MUX/DEMUX and perform a complete end-to-end link characterization or troubleshooting of active C-RAN, DAS and mobile fronthaul CWDM networks.



Applications

- Characterize end-to-end links with exact CWDM wavelengths
- Troubleshoot active networks with in-service testing capability
- Verify end-to-end continuity with the continuous wave source function
- Certification and troubleshooting of hybrid CWDM/DWDM networks (when paired with DWDM OTDR module and T-BERD/MTS-4000 V2)

Key Features

- CWDM8U version includes 8 wavelengths from 1471 nm to 1611 nm
- CWDM10U version includes 10 wavelengths from 1431 nm to 1611 nm
- CWDM10L version includes 10 wavelengths from 1271 nm to 1451 nm
- Integrated CW light source with modulation capability (same OTDR wavelengths)
- Eliminate OTDR interpretation errors with Smart Link Mapper (SLM) (icon based view of fiber link with splice, connector, MUX/DEMUX)
- Compatible with T-BERD/MTS-2000, -4000 V2 and -5800 platforms

DWDM OTDR Module – 4100-Series for T-BERD/MTS-2000, -4000 V2, -5800 V2 Platforms

The VIAVI DWDM OTDR solution enables performing a complete end-to-end link characterization and troubleshooting through MUX/DEMUX of newly deployed or active DWDM and Hybrid CWDM/DWDM networks. It's the perfect OTDR for cable, mobile, and telecommunications operators dealing with C-RAN and mobile front haul access networks, passive DWDM networks for cable TV business services, and next-generation FTTH networks.



Applications

- Verifying end-to-end continuity with integrated tuneable laser source prior to service turn-up
- Testing new DWDM wavelength routes without disrupting traffic on active channels
- Pinpointing faults and their exact locations while in service
- Certification and troubleshooting of hybrid CWDM/DWDM networks (when paired with CWDM OTDR module and T-BERD/MTS-4000 V2)

Key Features

- Tuneable DWDM OTDR in the C-band (1528 nm-1563 nm/191.70 to 196.10 THz)
- 50 GHz/100 GHz/200 GHz channel spacing based on the ITU-T standard grid
- 44 dB dynamic range for access and metro applications
- Integrated C-band tuneable laser source with modulation capability
- Eliminate OTDR interpretation errors with Smart Link Mapper (SLM) (icon based view of fiber link with splice, connector, MUX/DEMUX)
- Compatible with T-BERD/MTS-2000, -4000 V2 and -5800 platforms

Multi-Fiber MPO Switch Module for T-BERD/MTS-4000 V2 Platform

VIAVI T-BERD/MTS-4000 V2 OTDR Platform with MPO switch module is an all-in-one versatile solution to qualify, certify and troubleshoot multi-fiber MPO cables. Equipped with a single piece of equipment, field technicians no longer need to use fan-out/break-out cables to efficiently test and certify MPO links.

Well suited for use in high-density fiber environments, multi-fiber MPO cables eliminate the expense of running individual patch cords for each service turn-up. Widely used in Data Center interconnects, MPO cables are spreading into telecom access applications such as FTTH, FTTA, or C-RAN. The use of an MPO switch is the best way to accurately and quickly characterize individual fibers of an MPO cable with an OTDR.

SLM software applications (Enterprise-SLM or Cable-SLM) allows testing in Numbering mode (8, 12, or others) or in Labelling mode and automates test workflow, certification and reporting

FTTH-SLM:

- Tailored to PON testing through splitters (from ONT to OLT)
- Multiple pulses smart acquisition to discover any FTTH topologies and measure all their sections

FTTA-SLM:

- Auto-selection of best acquisition parameters
- Detection and identification (labels) of FTTA network elements along the fiber link

Enterprise-SLM:

- Labeling schemes per DataCenter / Enterprise TIA-606 standard
- Project / task management capability to easily control and document all test results
- Management of an optical switch to test all fibers, of a MPO cable, sequentially, after one-button press.
- Compatible with CERTiFi Enterprise workflow solution (cloud & mobile apps)

Cable-SLM:

- Project / task management capability to easily control and document all test results
- Management of multi-core fiber cables as separate projects with bird-eye view of entire cable testing progress

Applications

- Comprehensive Tier 2 (Advanced) fiber certification and troubleshooting for MPO fiber connectivity
- Data Center singlemode structured cabling
- FTTH/Access Networks MPO trunks
- Wireless Fronthaul (FTTA/C-RAN) MPO fiber cable

Key Features

- Singlemode 1x 12 MPO Switch Module
- Pinned APC MPO port for connection to MPO links to be tested
- SC/APC port for connection to OTDR test port
- Automatically controlled by the OTDR
- Enterprise-SLM and Cable-SLM Ready
- Compatible with T-BERD/MTS-4000 & 4000 V2 Platform



T-BERD/MTS-6000A V2 Compact Network Test Platform

T-BERD/MTS-6000A V2 is a compact and lightweight test platform designed for all phases of the network lifecycle from installation to maintenance of fiber networks. Modular in design, the T-BERD/MTS-6000A V2 offers an extensive portfolio of test functionality for multiple network layers.

The single Multi-Services Application Module (MSAM) provides an integrated solution for Ethernet, SONET/SDH, and higher-layer tests. Optical modules allow thorough testing of short-haul, long-haul, FTTH, CWDM, and high-speed 40 Gbps networks.

Applications

- OTDR testing of very short multimode or singlemode fiber links to ultra-long hauls (up to 220 km)
- PMD, spectral attenuation profile, and chromatic dispersion (CD) testing
- CWDM and DWDM optical spectrum analysis
- High resolution OTDR for Avionics (aircraft, spacecraft, satellite, UAV) and maritime (submarine & ship) fiber certification
- High resolution OTDR for Wireless and Enterprise/DataCenter (Tier 2) fiber certification
- FiberComplete fully automated bi-directional IL/ORL & OTDR certification

Key Features

- 8 inch touchscreen display
- Automated pass/fail fiber inspection analysis with optional P5000i microscope
- OTDR, CD/PMD, and OSA modules are compatible with the T-BERD/MTS-8000 scalable multitest platform
- Smart Link Mapper (SLM) eliminates OTDR interpretation errors without impacting test times
- Built-in optical power meter and VFL options

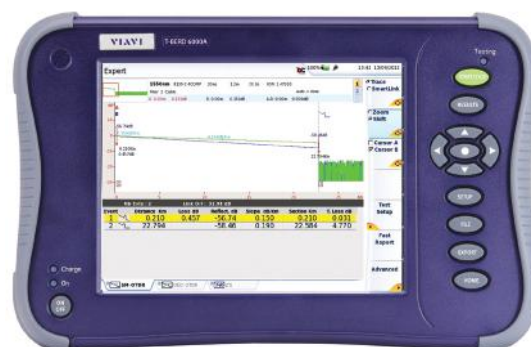

T-BERD/MTS-8000 Scalable Multitest Platform

Keep ahead of the telecommunications technology curve with the T-BERD/MTS-8000, the industry's most innovative and versatile test solution for modern and next-generation network deployments. Built to support current and ultra-high-speed transmission network testing needs, the T-BERD/MTS-8000 embeds the latest state-of-the-art technology for those planning long-term investments and is simply the best-in-test solution.

Based on the award-winning VIAVI T-BERD/MTS-8000 platform the T-BERD/MTS-8000 meets next-generation network challenges with additional fiber inspection and test, ROADM, and 40/100 Gbps test capabilities.



Applications

- OTDR testing of very short multimode or singlemode fiber links to ultra long hauls (up to 220 km)
- PMD, spectral attenuation profile, and chromatic dispersion (CD) testing
- PMD testing on fiber with live traffic and in-band & in-service OSNR testing in DWDM/ROADM systems
- CWDM and DWDM optical spectrum analysis
- FiberComplete fully automated bi-directional IL/ORL & OTDR certification

Key Features

- 10.4 inch high-visibility touch-screen display
- High-speed PowerPC processor, rugged SATA solid-state hard disk, and latest high-capacity LiON battery technologies
- 1 Gigabit Ethernet, wireless connectivity (3 G, Wifi, Bluetooth) and four USB interfaces
- Automated pass/fail fiber inspection analysis with optional P5000i microscope
- Compatible with T-BERD/MTS-6000 V2 compact network test platform test modules
- Smart Link Mapper (SLM) eliminates OTDR interpretation errors without impacting test times

8100-Series OTDR Modules for T-BERD/ MTS-6000A V2, -8000 Platforms

VIAVI 8100-Series OTDR EVO family includes the "8100A", "8100B", the "8100C", and the "8100D" modules for any singlemode or multimode OTDR application and test scenario from very short to ultra-long distances.

The optical performances of the 8100-Series OTDR modules combined with the complete suite of T-BERD/MTS platforms testing features ensure that any testing job is done right the first time.

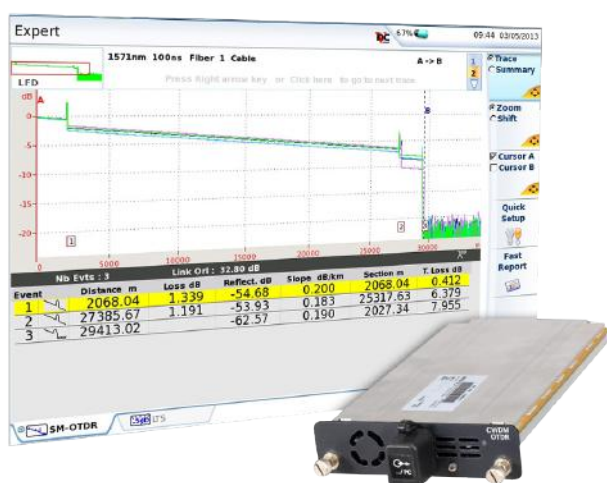

Applications

- Access, Metro, Long Haul and Ultra Long Haul fiber network characterization
- Tier 2 certification of enterprise and data center networks
- Advanced qualification and troubleshooting of FTTH/PON networks.
- Core fiber network upgrade to 40 and 100 Gbps
- Fiber monitoring in and out-of-service

Key Features

- Up to 50 dB dynamic range and 256,000 acquisition points
- ≤ 65 cm Event Dead Zone and 2.5 m Attenuation Dead Zone
- Integrated CW light source and broadband power meter on OTDR port (singlemode wavelengths)
- PON optimized to test up to 1x128 splitter type
- Combined singlemode/multimode version

Modules	8100A				8100B				8100C				8100D	
Module	E8146A	E8126B	E8136B	E81165B	E81162C	E8126C	E8136C	E8139C	E8126D	E8136D				
Wavelength	850/1300 1310/1550 nm	1310/ 1550 nm	1310/ 1550/ 1625 nm	1650 nm in-service	1625 nm in-service	1310/ 1550 nm	1310/ 1550/ 1625 nm	1310/ 1490/ 1550 nm	1310/ 1550 nm	1310/ 1550/ 1625 nm				
Dynamic range	24/ 24 dB 40/ 40 dB	41/ 40 dB	41/ 40/ 40 dB	40 dB	47.5 dB	47.5/ 47 dB	47.5/ 47/ 47.5 dB	47.5/ 46/ 47.5 dB	50/ 50 dB	50/ 50/ 50 dB				
Fiber	Multi-mode/ singlemode	Singlemode	Singlemode	Singlemode	Singlemode	Singlemode	Singlemode	Singlemode	Singlemode	Singlemode				
Power meter		✓	✓	✓	✓	✓	✓	✓	✓	✓				
Light source	✓	✓	✓	✓	✓	✓	✓	✓	✓	✓				
Event dead zone	Multimode: 0.25 m Single-mode: 0.60 m	0.65 m				0.6 m				0.5 m				
Attenuation dead zone	2 m	2 m				2 m				2.5 m				
Splitter attenuation dead zone	25 m after a 15 dB splitter loss (single- mode only)	25 m after a 15 dB splitter loss				25 m after a 15 dB splitter loss/60 m after a 18 dB splitter loss				15 m after a 15 dB splitter loss				

FiberComplete Integrated Loss, ORL and OTDR Modules – 8100-Series for T-BERD/6000A V2, -8000 Platforms

You can now equip each technician with a single piece of equipment that fulfills all of the traditional fiber testing requirements. The VIAVI 8100-Series Fiber Characterization module is part of the EVO family that revolutionizes fiber characterization testing. This unique module combines FiberComplete testing and broadband source functions with only one fiber connection. It supports the characterization of optical link commissioning as well as network upgrades, ensuring efficient testing and an optimal workflow. FiberComplete cuts testing in half with fewer connection and disconnections, automatic continuity check and an intelligent fault finder, minimizes training and gets reliable measurements using a single connections port that combines a fully automated process with easy-to-read results, and optimizes workflow by compiling tests results into one complete cable view and automatically storing all measurements in one folder.

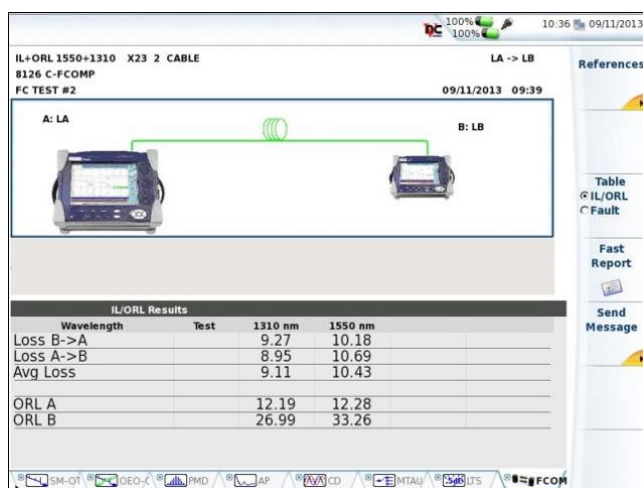

Applications

- Certification, maintenance and troubleshooting of any fiber optic links.
- Installation and commissioning of Access, Metro and Very Long Haul networks
- 4 G/LTE backhaul high-speed upgrades
- Fiber network bit rate upgrades to 10/40/100 G
- Troubleshoot in FaultFinder mode for immediate results

Key Features

- Single module, single port testing
- Make one connection, one-touch automated measurements
- Automatically measure bidirectional OTDR, IL, and ORL with one
- Real-time continuity check and automatic product pairing
- Manage fiber and cable results with on-board report generation
- Step-by-step wizard for initial IL/ORL referencing

Hi-Res Multimode OTDR Solution

The VIAVI Hi-Res multimode OTDR solution characterizes and locates faults on very short multimode fiber runs deployed in aircraft, spacecraft, submarines, and ships. Also suitable for use in other short run fiber environments such as Wireless (DAS, 4 G, 5 G, C-RAN) deployments and Enterprise/ Data Center environments. It is the industry's most compact, lightweight, and portable unit, enabling testing in areas where access to fiber is difficult or limited.



Applications

- Fiber optics cable assembly manufacturing
- Fiber testing in commercial or military aircraft, spacecraft or Unmanned Aerial Vehicles (UAV)
- Fiber testing in submarines and ships
- Fiber certification (Tier 2) and troubleshooting in Enterprise and Data Center environments

Key Features

- Industry-leading dead-zone performance
- Streamlined user interface and error-free setup
- Connector end-face inspection and automated pass/fail analysis
- FastReport onboard PDF report generation
- TIA/IEC pass/fail thresholds for Tier-2 certification
- Eliminate OTDR interpretation errors with Smart Link Mapper (RDZ-SLM)
- Compatible with T-BERD/MTS-6000A V2 Platform

Distributed Fiber Optic Sensing OTDRs

Distributed fiber optic sensing allows you to use specialized DTS Raman or DTSS Brillion OTDR technology to measure strain or temperature continuously on a fiber. We offer the DTSS or DTS OTDRs in a portable or rack-mounted form factor.

The DTSS B-OTDR for Distributed Fiber Optic Sensing of Strain, Temperature and Optical Loss is paired with the portable DTSS on the T-BERD/MTS-8000 platform to bring new DTSS technology to the field in a uniquely portable and high powered combination. This product can also be provided in a rack-mounted optical test unit within an OTU-8000 to be combined with ONMSi for a permanent fiber monitoring solution.

DTSS use cases:

- Fiber characterization with B-OTDR reveals fiber strain and elongation or temperature.
- Ensure installations, like submarine cables are done correctly without strain.
- Reduce and reverse cable strain by locating and releasing it before it breaks the cable or reduces the cable life using the portable DTSS.



T-BERD/MTS 8000 with DTSS or OTU-8000 with DTSS or DTSS

Applications

- Temperature & strain threshold monitoring
- Pipeline Monitoring
- Telecommunications cable strain testing for manufacturing, installation and maintenance
- Power cable monitoring – hot spot detection
- Structural Health Monitoring (SHM)

Key Features

- Loss, temperature and strain measurement (DTSS) or temperature and loss (DTS) in one OTDR
- Single-ended solution requiring only one fiber with multi-port measurements
- Portable and rack mounted form factors
- Portables: Compact, modular and lightweight – no generator required and pair with Fiber Sensing Trace post processing software
- Rack-able form factor pairs with VIAVI Fiber Monitoring Solution (ONMSi)
- Low power consumption – rack-able version
- Battery operated – portable version
- Remote connectivity

Learn more about Fiber Sensing on viavisolutions.com

DTS use cases:

- Fiber characterization with Raman OTDR reveals fiber temperature and all classic OTDR measurements as well for optical loss.
- Utilize the DTS to identify the right cable at a far end by heating or cooling the cable when you don't want to inadvertently disconnect the wrong cable and take traffic down.
- Spot electrical hot spots or potential leaks or locations where you are using a fiber for temperature sensing to determine if the ambient temperature is within tolerance of target.



Optical Dispersion Analysis

Chromatic dispersion (CD) and polarization mode dispersion (PMD) create transmission issues in high-speed networks. These speed-limiting phenomena threaten the integrity of the signal starting at 10 Gbit/s, which in turn affects the quality of service. VIAVI optical dispersion measurement module (DISPAP) offers chromatic dispersion (CD), polarization mode dispersion (PMD), and attenuation profile (AP) test functions in one plug-in module. It is the industry's most compact and integrated dispersion solution dedicated to field testing fiber optic networks.

Optical Dispersion Measurement Module

Chromatic Dispersion

- Two-ended test using one fiber based on phase shift method
- Full wavelength range characterization
- Suitable for any fiber type
- High dynamic range up to 55 dB

Polarization Mode Dispersion

- Based on the fixed analyzer method using fast Fourier transform (FFT)
- Established in the market
- High dynamic range up to 65 dB

Attenuation Profile

- dB loss/km over the full wavelength range: 1260–1640 nm
- Allows CWDM and DWDM transmission band characterization
- Water peak (1383 nm area) characterization



Optical Broadband Sources for Dispersion Testing

VIAXI Optical Dispersion Modules require a broadband light source at the far end to perform CD, PMD and AP measurements. Three broadband sources with different wavelength range coverage and output power are available depending on the application.



	OBS-500 Handheld Broadband Light Source	OBS-550 Handheld Broadband Light Source with High Dynamic (HD) Mode	BBS2A Broadband Light Source Module
Wavelength range	1485 nm to 1640 nm	1485 nm to 1640 nm / 1530 to 1610 nm (HD mode)	1260 nm to 1640 nm
Output Power level	>8 dBm	>8 dBm / >16 dBm (HD mode)	>8 dBm

Test results provided at the touch of a button

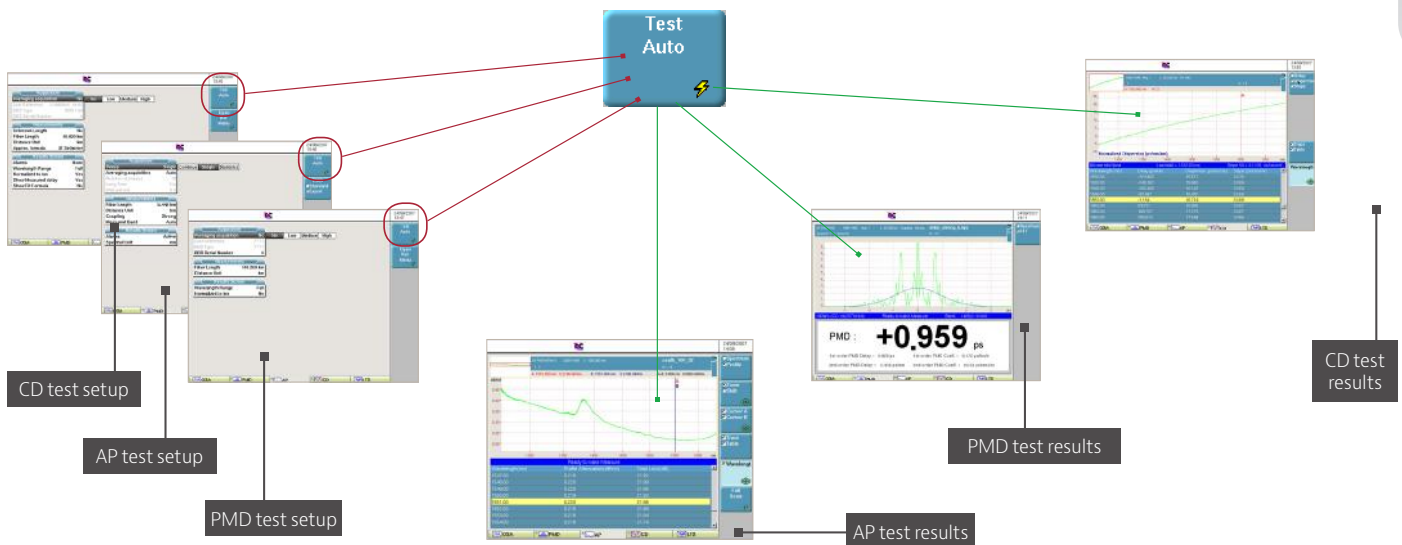

Our compact and integrated dispersion testing solutions perform fiber characterization links as well as optical network characterization with high efficiency and reliability (point-to-point or complete network).

- PMD module (E81PMD)
- CD module (E81CD)
- Combines PMD/CD and attenuation profile testing in a single module (E81DISPAP)

Optical Spectrum Analysis

The range of compact VIAVI Optical Spectrum Analyzers (OSA) are tailored for spectral measurements in CWDM systems in the access network as well as DWDM systems in the backbone and for Next Generation 40/100/200/400 G high-speed network backbones. The range also features an OSA version for ROADMs based systems or 40 G networks with tight channel spacing, providing true OSNR measurements based on VIAVI unique in-band OSNR method.

Supported by applications such as the WDM-Expert VIAVI solutions address analysis complexities added due to networks carrying a mix of 2.5/10/40/100 G data rates and services. In addition to traditional information about the wavelength, power, and noise for each channel, WDM-Expert indicates the transmitted data rate per channel as well as the presence of 40/100 G or higher speed polarization-multiplexed (Pol-Mux) signals. Allowing users to correlate OSNR results to data rates instantaneously without the need to look up network plans and to quickly identify the Pol-Mux signals of coherent systems, all in real-time with no impact on the measurement times of the OSA scans. OSA usability is further simplified through customized results displays with user-defined templates for results tables of content.

COSA-4055 CWDM Optical Spectrum Analyzer Module for T-BERD/MTS-2000, -4000 V2, -5800 V2 Platforms

The COSA-4055 is the smallest CWDM optical spectrum analyzer (OSA) on the market. The COSA-4055 module for the T-BERD/MTS-2000, -4000 V2, and -5800 platforms offers the functionality and speed of an OSA in a handheld form factor at a fraction of the price of a traditional OSA. It is an ideal test tool for service providers to install, maintain and upgrade metro/access links and CWDM systems. It measures wavelengths and power levels of CWDM channels and displays the complete spectrum.



Applications

- Performance verification in Metro Access networks
- Maintenance and troubleshooting of CWDM networks
- Upgrade of CWDM networks
- Spectral and drift testing of CWDM sources
- Point-to-point Mux/Demux and point-to-multipoint OADM testing

Key Features

- Fast scanning speed (4s)
- Power and wavelength drift test application
- Pass/fail analysis
- 1260 to 1625 nm wavelength range
- ITU-T G. 694.2 CWDM wavelength and customized grids
- Compliant with ITU-T G.695 and G674.2 standards
- Additional slots for up to two SFP CWDM transceivers

DWDM Optical Channel Checker Module (OCC-4056C) for T-BERD/MTS-2000, -4000 V2, -5800 V2 Platforms

The OCC-4056C is the most complete DWDM optical channel checker (OCC) on the market. The OCC-4056C module for the T-BERD/MTS-2000, -4000 V2 and -5800 V2 platforms offers OSA like functionality and speed in a handheld form factor, perfect for successfully deploying and maintaining wavelength routes for Fiber Deep, Remote PHY, C-RAN and 5G applications. It is an ideal test tool for service providers to install, maintain and upgrade metro/access links and DWDM systems. It measures wavelengths and power levels of DWDM channels and displays the complete spectrum.



Applications

- Qualify any DWDM channel Frequency and Power level
- Validate wavelength routes for Fiber Deep & Remote-PHY
- Qualify forward/return path links through Mux and Demux
- Spectral and drift testing on DWDM sources
- Performance verification in Metro Access Networks
- Maintenance and troubleshooting of DWDM networks

Key Features

- Supports ITU-T G.692 DWDM grid with 50/100 and 200GHz channel spacing
- Supports C-band applications (Ch61 to Ch12)
- Complete spectral trace & fast scanning speed (<4s)
- Drift measurements for wavelength and power
- Zoom and marker functions
- Pass/Fail analysis
- Dual SFP slots for fixed or tunable SFP

OSA-110M/110H/110R Compact Full-Band OSAs

The OSA-110 Series is the next generation of compact VIAVI optical spectrum analyzer (OSA) modules with unmatched size and performance. Ideal for field use, an OSA-110 module fits inside the MTS-6000A V2 series platform, offering the smallest full-band OSA solution on the market. The OSA-110 Series is suitable for all optical coarse wavelength division multiplexing (CWDM) and dense wavelength-division multiplexing (DWDM) networks down to 33 GHz channel spacing.

In addition to standard features provided by the OSA-110M, the OSA-110H integrates a high-power measurement capability, making it the ideal tool for cable TV operators. The OSA-110R includes the well-known VIAVI in-band measurement technique to measure the true OSNR in ROADM-based networks and in 40 Gbps systems with overlapping spectra.

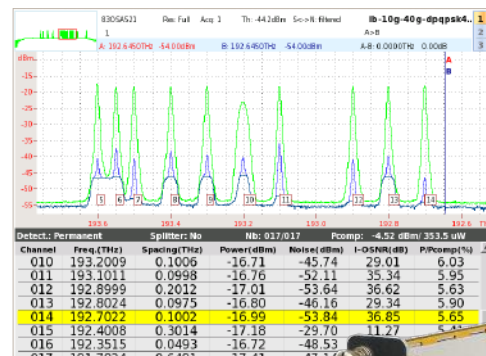

Applications

- Deploying and maintaining DWDM metro and core networks
- Installing and maintaining CWDM systems in CATV, access, and mobile backhaul
- Verifying high-speed 40/100 G interfaces
- Provisioning and troubleshooting ROADM networks

Key Features

- Full-band measurement: 1250 nm up to 1650 nm
- Guaranteed ± 0.05 nm wavelength accuracy with built-in wavelength calibrator
- High power measurement version (up to +30 dBm) for CATV applications (OSA-110H)
- In-band OSNR measurement version (OSA-110R)
- Compatible with the T-BERD/MTS-6000A v2, -8000 Platforms

OSA-500M /500R/500RS High Performance Full-Band OSAs

Targeted for advanced test solutions, VIAVI OSA-500x modules represent high-performance use for full-band spectral testing. Their industry-leading 0.038 nm optical resolution bandwidth makes these optical spectrum analyzers ideal for unmatched performance testing in ultradense wavelength-division multiplexing (DWDM) networks with channel spacing down to 25 GHz.

All instruments include an internal wavelength calibrator that guarantees 0.010 nm.

unsurpassed wavelength accuracy without external recalibration.

The OSA-500M is a general-purpose high-performance OSA for use in installing and maintaining DWDM networks. OSA-501M provides a unique channel-drop function to isolate single DWDM channels from the spectrum during maintenance and troubleshooting. OSA-500 improves the optical-filter dynamic range for testing the highest DWDM system OSNR values. OSA-500R and OSA-500RS include a new technique to measure true in-band OSNR in ROADM-based and in 40 G systems with overlapping spectra. The OSA-500R is the standard instrument for measuring in-band OSNR, the OSA-500RS is the high-speed version that can complete measurements in less than 30 seconds.

Supported by the T-BERD/MTS-8000 platform.

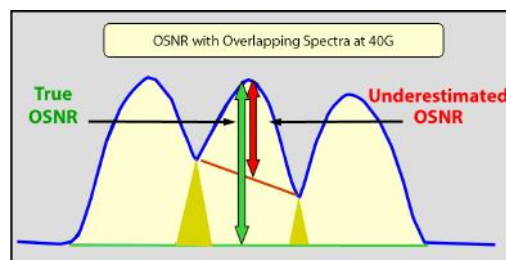

Applications

- Measurement of the true in-band OSNR in Agile Optical network – including testing ROADM & dispersion compensating modules
- DWDM and CWDM system testing during installation, maintenance, and network upgrade
- Install and maintain CWDM systems in CATV, access, and mobile backhaul
- Automated DWDM passive and active component testing
- Verification of ROADM configurations in Agile Optical Networks

Key Features

- Full-band 1250–1650 nm for all CWDM and DWDM networks
- New Optical Polarization Splitting method (OPS-method, VIAVI patent pending) for measuring the true in-band OSNR in ROADM based networks
- Channel drop option for troubleshooting and fault location, single channel isolation for in-depth signal analysis with BERT or Q-factor meter
- Future-proof signal analysis for 40/100 G data rates, and next-generation modulation formats
- Software option for PMD testing
- Internal wavelength calibrator guarantees unsurpassed 0.010 nm wavelength accuracy without external recalibration

OSA Modules: High resolution OSA-610 for T-BERD/MTS-6000A V2, -8000 Platforms

VIAVI OSA-610 High Resolution Optical Spectrum Analyzer offers outstanding resolution bandwidth and unprecedented wavelength accuracy that is 5 to 10 times better than traditional OSAs, making it ideal for existing applications but also advanced signal analysis such as 400 G super channels. It is a compact solution for lab and field where reliability and performance are critical. Compatible with the T-BERD/MTS-6000A v2, -8000 Platforms.



Applications

- Qualify 10/40/100/400 G components and systems
- Validate and deploy 100 G & 400 G flex-grid DWDM systems
- Qualify Nyquist signals and super channels

Key Features

- Industry's first field OSA that fully analyzes 400 G Nyquist WDM signals
- Extended C-band acquisition range (1526-1568 nm)
- Frequency, power level and OSNR measurement
- 3 pm wavelength accuracy
- Side-mode suppression ratio measurement capability
- The smallest and lightest high-performance 400 G ready OSA available

OSA Modules: In-service Pol-Mux OSCA-710 for T-BERD/MTS-8000 Platforms

The OSCA-710 is the first Optical Spectrum & Correlation Analyzer that can perform in-band OSNR measurement in high speed, ROADM based DWDM networks using polarization multiplexing transmission formats without shutting down optical channels. This module uses a novel, proprietary spectral correlation measurement technique (VIAVI patent) along with an ultra-high resolution coherent receiver for complete signal characterization in amplitude, frequency, phase and polarization.

Supported by the T-BERD/MTS-8000 platform

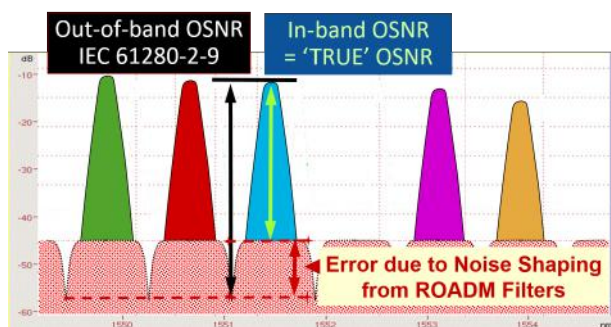

Out-of-band versus 'True' in-band OSNR in ROADM networks

Applications

- In-band and in-service OSNR measurement, characterize traffic without shutting down the network or individual channels
- Installation, commissioning and maintenance testing of core and metro DWDM networks with or without ROADMs
- Testing undersea communication links
- Qualification of any fiber optic link utilizing coherent detection

Key Features

- Power, wavelength, and in-band OSNR measurement for any kind of data rates and modulation schemes, including polarization-multiplexed signals
- Supports PM-BPSK, PM-QPSK, and PM-xQAM modulation formats used in 100, 200, and 400 G systems
- Tolerant of high chromatic dispersion (CD) and polarization mode dispersion (PMD)
- Measures per channel in-service CD
- Coherent OSA design with ultra-high resolution bandwidth for testing Nyquist- and Super-Channels

OCC-55 CWDM Optical Channel Checker and OCC-56C DWDM Optical Channel Checkers are compact and low-cost test alternative solutions to optical spectrum analyzers (OSA) for field service groups tasked with the installation, maintenance and upgrades of WDM systems testing. These selective power meters scan the WDM channels according to ITU-T wavelength grid and automatically records wavelength/frequency and related power level.



Applications

- Installation, maintenance and upgrade of CWDM and DWDM systems
- Analysis of single channel before MUX and DEMUX Qualification of multiplexed signals
- In-service measurement and network element verification Channel drop testing at optical add/drop multiplexers (OADM)

Key Features

- ITU-T G.694.2 CWDM channels measurements (up to 18 channels) (OCC-55)
- ITU-T 50/100/200 GHz DWDM channels (OCC-56C)
- Channel drift monitoring
- Bar Graph and Table of results display mode
- Light and compact (0.5 kg/1.1 lb)
- Report generation via OFS-355 Smart Optical Reporting Software

Post-Analysis PC Software

Post-processing PC software offers fast and efficient viewing, editing, analyzing, and reporting of optical fiber test data.

Ordering Information

Description	Part Number
FiberTrace 2 PC Software FiberTrace 2 enables users to view, edit, analyze and print, in a professional format, any optical test data acquired in the field with T-BERD/MTS platforms.	EOFS-100
FiberCable 2 PC Software FiberCable 2 also provides the capability to generate high fiber counts, cable OTDR acceptance reports, and fiber-characterization reports combining various test results in a single document.	EOFS-200



Optical data post-processing software is available in two versions.

- FiberTrace 2 lets users view, edit, analyze, and print, in a professional format, any optical test data acquired in the field with VIAVI T-BERD/MTS platforms. It is ideal for small fiber jobs.
- FiberCable 2 adds the ability to generate high-fiber-count cable OTDR acceptance reports and fiber-characterization reports combining various test results in a single document. It is ideal for the analysis and characterization of large groups of fibers.

Asset, Data, and Workflow Management

StrataSync

RFoG, EPON, GPON, HFC, DOCIS

Ethernet, Business Services, CWDM, DWDM

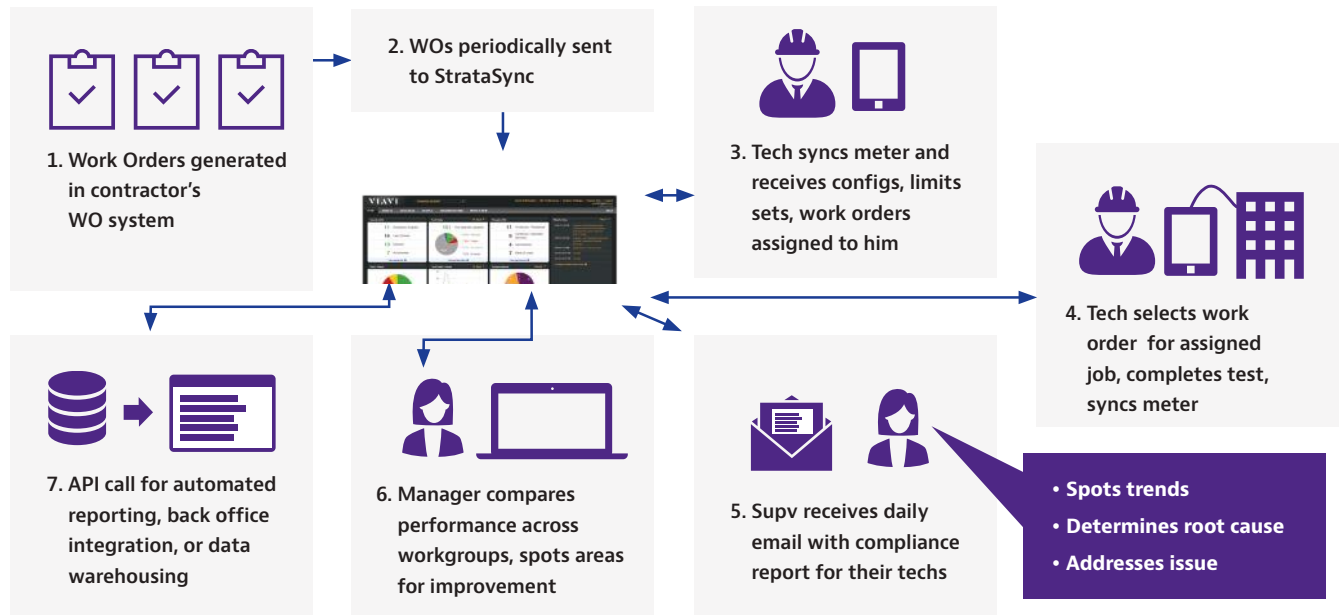

Key Features

- Cloud-enabled architecture provides secure, easy network access from anywhere
- Complete asset management also tracks non-VIAVI instruments
- Automation simplifies update of instrument firmware, options, and configuration files
- No charge for StrataSync Core functionality

Applications

- Instant test data transfer for invoicing
- Centralized management of field instrument software, configuration, and test data
- Floating SW license and option management
- Self admin of instruments (Tech Portal)
- Tech performance tracking

CERTiFi

Powered by the VIAVI StrataSync platform, CERTiFi empowers every team member with the information needed to complete tasks accurately and on time.

With CERTiFi, team members establish alignment at every stage of their project, from creating design requirements and assigning tasks to performing tests and analyzing project metrics in real time. Manage your projects with confidence and equip your team to succeed with CERTiFi.

Supports SmartClass Fiber OLTS-85/-85P, MPOLx, T-BERD/MTS 2000 and 4000 OTDR, and Certifier 10/40G



Application

- Design and manage multiple projects with a web-based interface
- Assign projects to consultants, field technicians, sub-contractors, or other team members
- Preload test instruments with tasks and required test criteria such as label lists, acceptance criteria, notes, and more
- Provide site leads with real-time test results and project statuses on mobile device

Key Features

- Manage your projects with confidence at every stage
- Align your team and project specifications in one place
- Communicate job requirements clearly and in real time
- Track project status and analyze results from anywhere
- Assign tasks directly to team members
- Deploy tasks directly to instruments with the CERTiFi mobile application

Optical Network Management

SmartOTU™

A plug-and-play fiber monitoring solution

SmartOTU software monitors fibers longer than 150 km in all directions depending upon the OTDR module selected. It monitors both dark and live fiber and it is ideal for all optical networks for network security protection and pinpointing events such as fiber tapping, to a few tenths of a decibel. SmartOTU is a standalone remote fiber test solution that can be deployed right out of the box with no training or IT configuration required. SmartOTU does not require any additional server or software applications — a simple web browser is enough to access all functionality, including mapping. SmartOTU displays the exact GPS location of a fault on widely-available, cloud-based mapping such as Google, Bing, or legacy GIS. SmartOTU is fully compatible with the VIAVI optical network monitoring system (ONMSi) and can be upgraded to be a comprehensive remote fiber test system as the network grows. SmartOTU is enabled by either the modular OTU-8000 hardware or the ultra-compact OTU-5000 that is optimized for in service monitoring.

The modular OTU-8000 allows you to change wavelengths by installing several choices of OTDR modules or to utilize the industry's first tunable DWDM OTDR with 44 wavelengths. This allows you to perform fiber monitoring with short, medium and long distance remote OTDR test in any location in the network where you can install a small probe. The tunable DWDM module also allows you to test beyond an add/drop MUX for network operators with Distributed Access Architecture with R-PHY devices to enable testing deeper into the network on a specific wavelength.

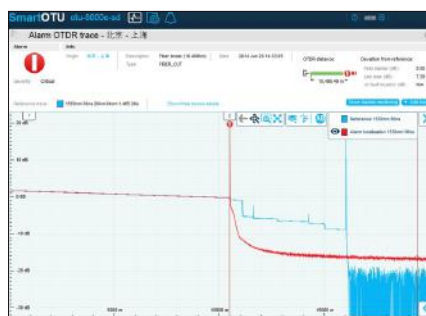

Applications

- Optical fiber monitoring
- "RIP" monitoring (Public Initiative Network)
- Proactive maintenance – Fiber security — tap detection
- Ideal for datacenter monitoring to ensure SLA compliance

Key Features

- Easy-to-use interface with Web browser access
- E-mail and SMS notifications, SNMP interface, Secure communication (HTTPS) on request
- Instantaneous view of current OTDR measurement
- Deploy right out of the box — no server or local PC required
- Fault localization on cloud-based apps or legacy GIS
- Compatible with the VIAVI optical network monitoring system (ONMSi)

Optical Network Management System (ONMSi)

Fiber Network Visibility that Scales for Both PON and Point-to-Point Networks

The ability to provide quad/triple play and passive optical network (PON) architectures with optical splitters has made fiber monitoring an even bigger challenge. VIAVI ONMSi is an optical network monitoring system that expands network visibility right from the core across the PON and into the premises—improving operational support and quality-of-service (QoS) for the network. ONMSi is a remote fiber test system that scans the fiber network 24/7 and automatically detects and locates faults without having to dispatch technicians in the field. VIAVI offers the industry's highest performance OTDR technology to produce an accurate, high resolution trace to locate faults, intrusions and degradation. Simply place an OTU (Optical Test Unit probe) to monitor fibers. The OTU integrates an optical time domain reflectometer (OTDR) and an optical switch to constantly compare baseline data to current data. It sends alarms if any fiber degradation occurs allowing your team to proactively maintain the network and protect it from intrusions.

VIAVI offers two types of OTUs that allow you to optimize both the type of OTDR module you need and the footprint and price point in your network. You can mix and match the OTU-8000 and the OTU-5000 in the same monitoring system to achieve full coverage of your network. The system can be used for PON construction and service provisioning, ongoing monitoring, infrastructure monitoring and network security applications.

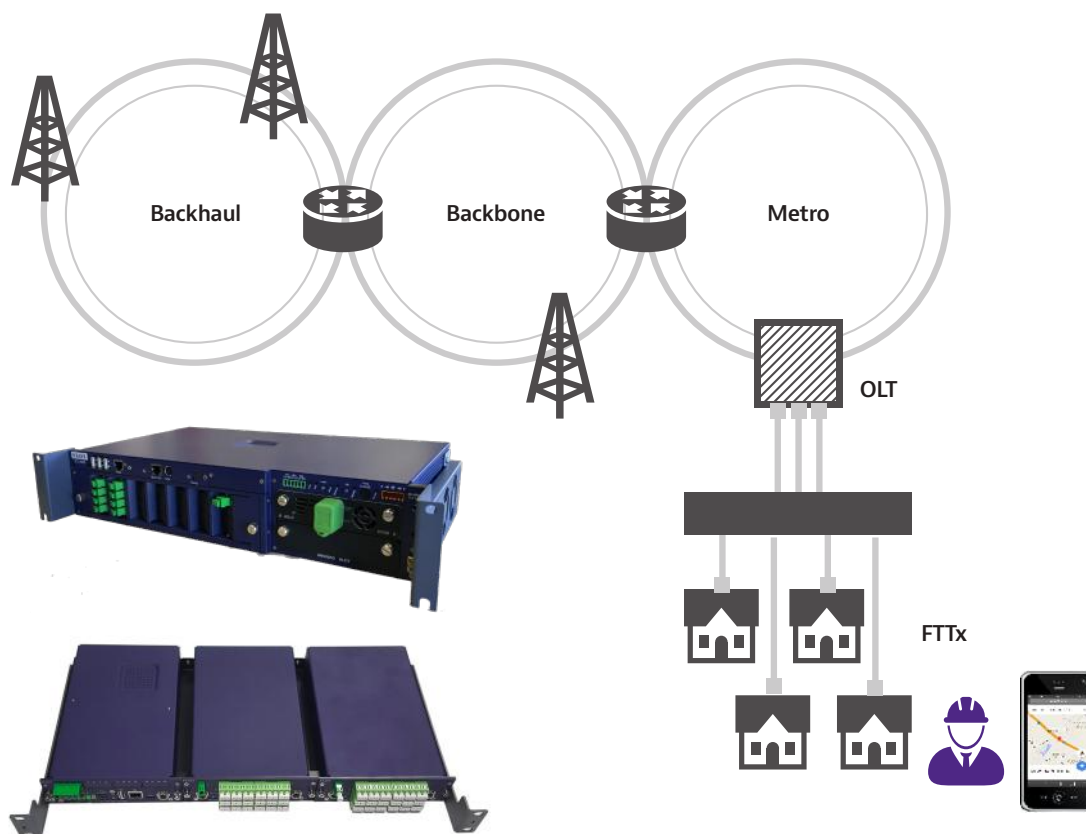
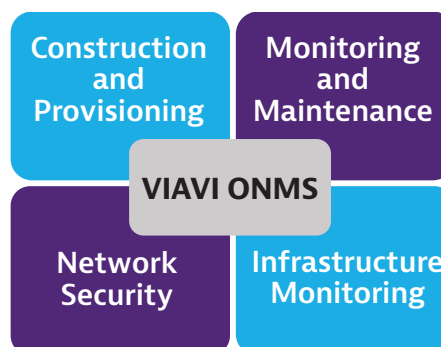

ONMSi offers a comprehensive fiber monitoring solution: it supports metro, core, access, and PON networks.

Improving Data Center Interconnect Uptime

VIAMI Data Center Interconnect Vulnerability Monitoring

DCI surveillance provides the visibility needed to immediately identify, locate and resolve events and network vulnerabilities in near real-time:

- Proactively track network performance
- Locate faults and reduce MTTR
- Ensure uptime/SLAs
- Enhance security
- Drive down labor related OPEX

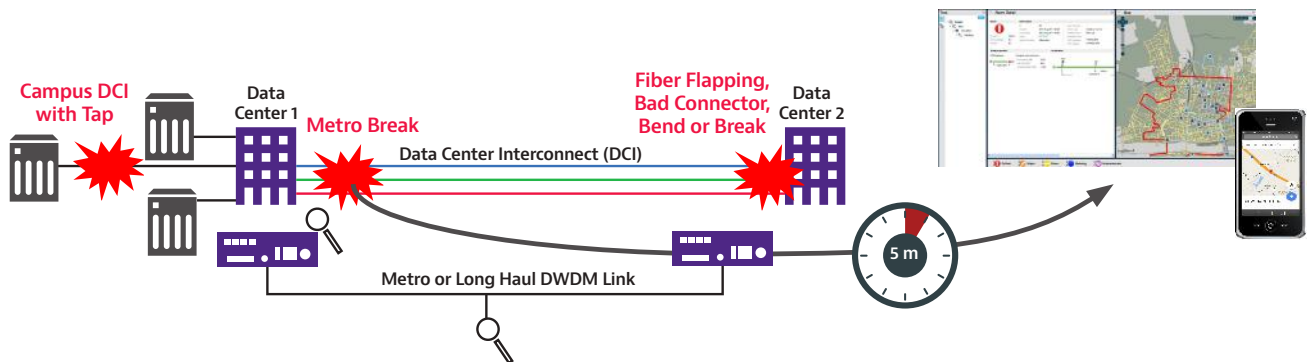



Contact us **+1 844 GO VIAVI**
To find the VIAVI office nearest you,
visit **[viavisolutions.com/contact](https://www.viavisolutions.com/contact)**

For further information
on any of these products,
please scan this QR code
or contact your VIAVI
representative.



© 2019 VIAVI Solutions Inc.
Product specifications and descriptions
in this document are subject to change
without notice.

[viavisolutions.com](https://www.viavisolutions.com)